

DESIGN Umberto Asnago & Valerio Sommella – 2022



Informazioni tecniche.

Struttura. In legno massello di pioppo (stagionato “naturalmente” per almeno 3 anni) con elementi in multistrato di pioppo; giunzioni ad incastro con spine cilindriche. Il molleggio è garantito da cinghie elastiche in polipropilene e lattice naturale. L'im-bottitura della struttura è ottenuta con lastre di poliuretano espanso indeformabile a densità differenziate (30÷35 kg/m³) esente da CFC ricoperto da ovatta poliestere e vellutino accoppiato.

Cuscini. Cuscini di seduta sono completamente in poliuretano espanso a densità differenziate (35-40 kg/m³). I cuscini di schienale sono completamente in piuma canalizzata.

Base. Piedini in lamiera d'acciaio con dettaglio in cuoio. Disponibili in finitura verniciata a polveri epossidiche in colore titanio.

Rivestimento. Disponibile in tessuto e pelle; sfoderabile solo per i cuscini di seduta e di schienale.

Mobile libreria. I moduli libreria ed il tavolino sono realizzati in acciaio verniciato a polveri epossidiche in colore titanio e rivestiti parzialmente in cuoio.

Technical features.

Frame. In solid poplar heartwood (“naturally” seasoned for at least 3 years) with connecting elements in poplar plywood; dap joints with cylindrical dowels. The webbing is secured by elastic polypropylene and natural latex belts. The framework is upholstered with contoured sheets of resilient, CFC-free polyurethane foam (with density of 30÷35 kg/m³) covered by polyester wad-ding and bonded plush.

Cushions. The seat cushions are available completely in polyurethane foam with different density(35-40 kg/m³). The back cushions are always feather-filled.

Base. Supports in steel sheet with details in saddle leather. Available epoxy powder painted in titanium color.

Covers. Available in fabric or leather; removable covers only seat and back cushions.

Bookcase cabinet. The bookcase cabinets and the coffee table are made of epoxy powder coated steel in titanium color and partially covered in saddle leather.

POLTRONE e DIVANI – ARMCHAIRS and SOFAS

ASSO00POLT124

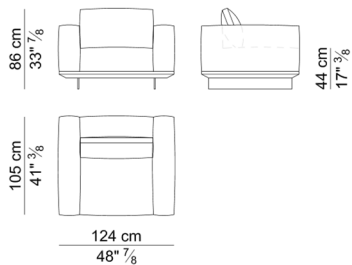

ASSO00POLT144

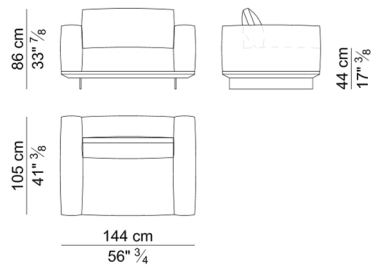

ASSO00DIVA204

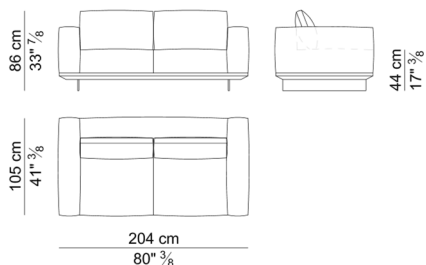

ASSO00DIVA224

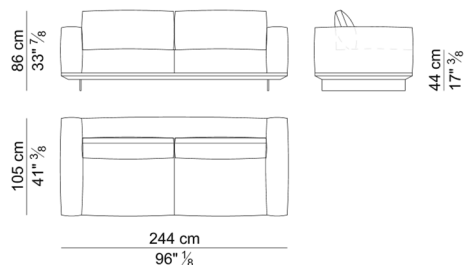

ASSO00DIVA284

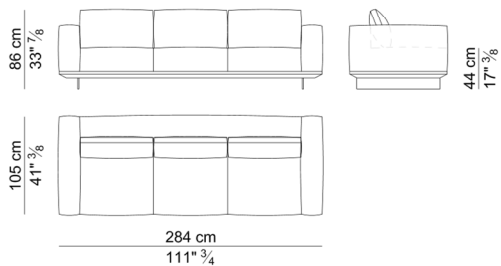

ASSO00DIVA344

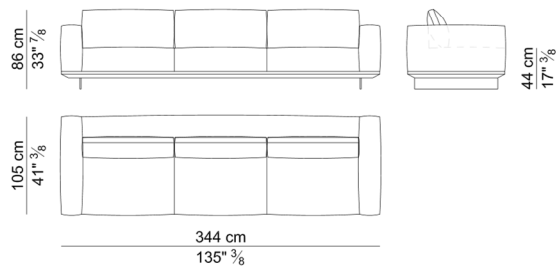

ELEMENTI SINISTRI - LEFTSIDE UNITS

ASSO00PO102SX

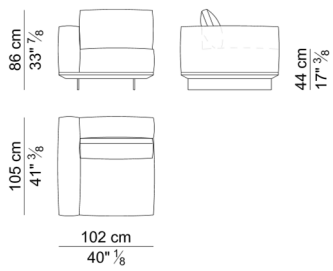

ASSO00PO122SX

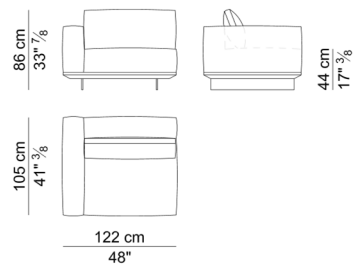

ASSO00DI182SX

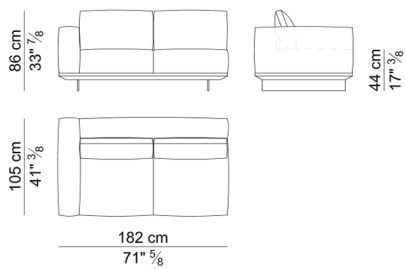

ASSO00DI222SX

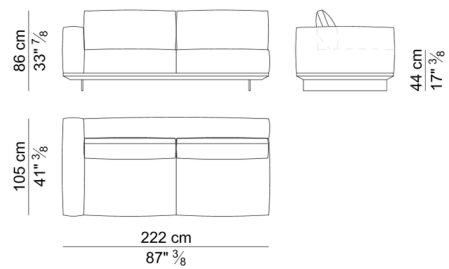

ASSO00DI262SX

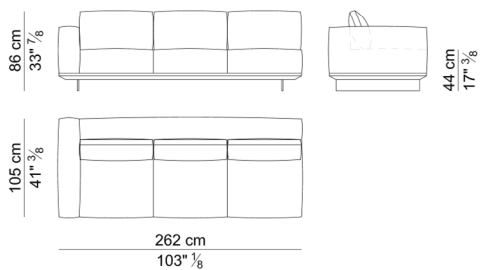

ASSO00DI322SX

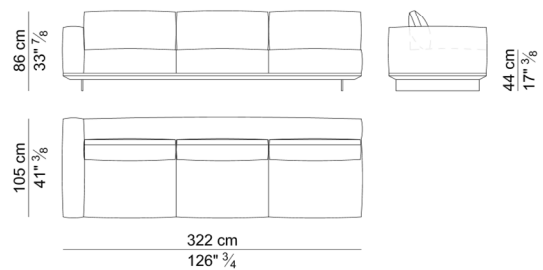

ELEMENTI DESTRI – RIGHTSIDE UNITS

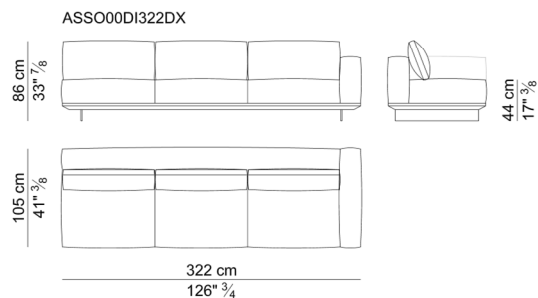
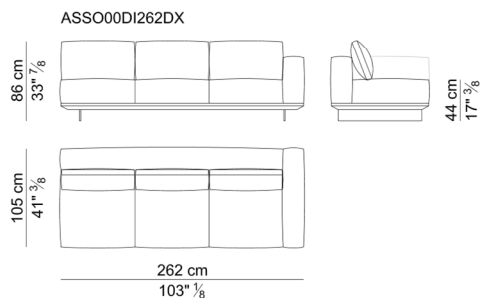
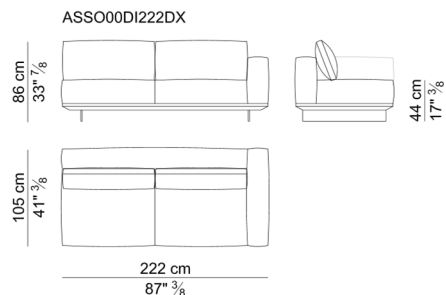
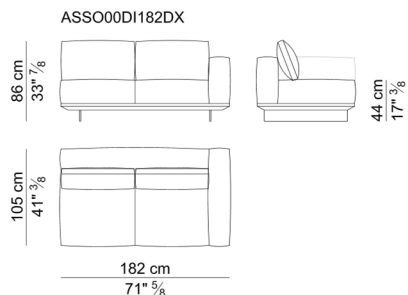
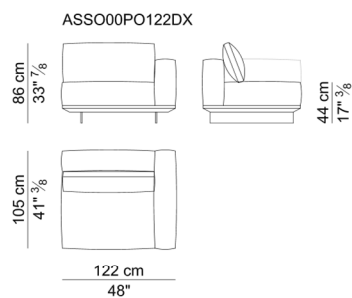
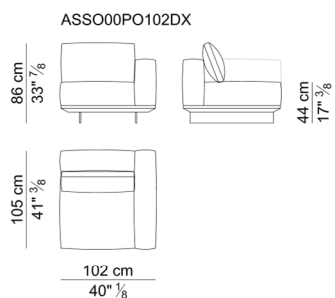

CHAISE LONGUES SINISTRE – LEFT CHAISE LONGUES

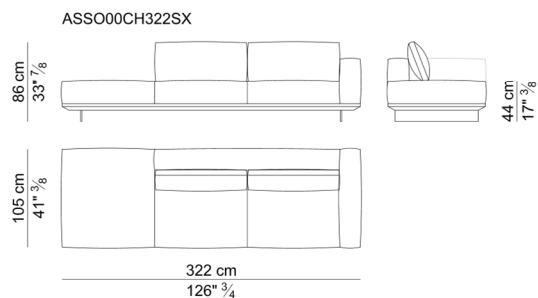
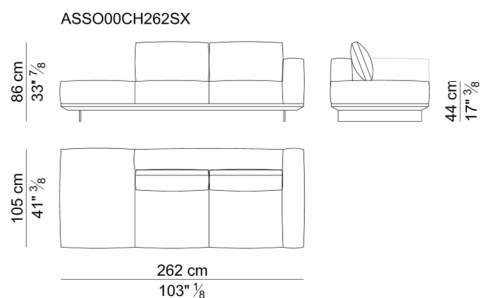
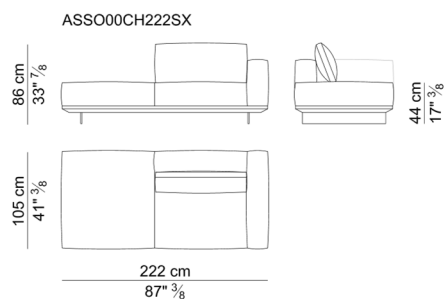
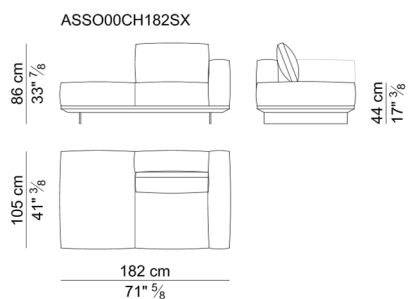

CHAISE LONGUES DESTRE – RIGHT CHAISE LONGUES

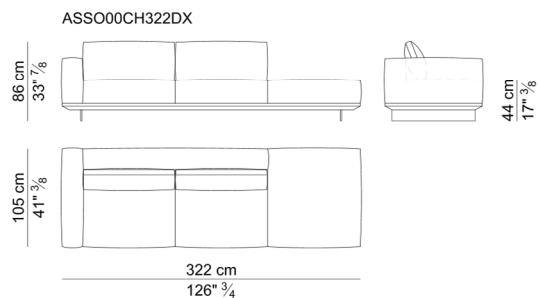
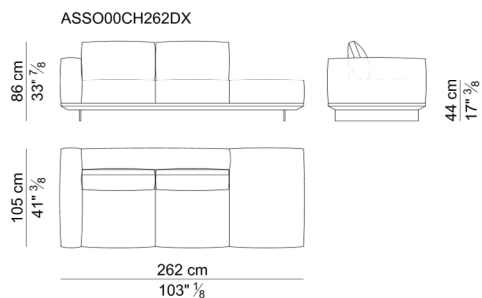
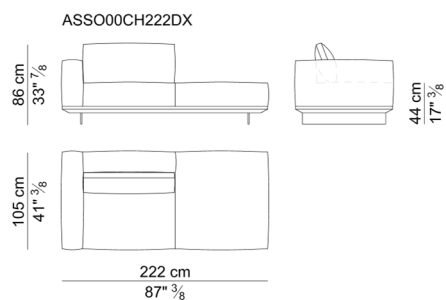
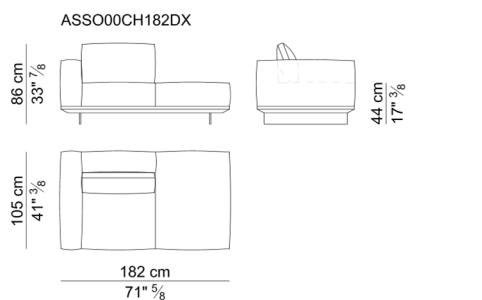

PENISOLE SINISTRE – LEFT LINEAR CHAISE LONGUES

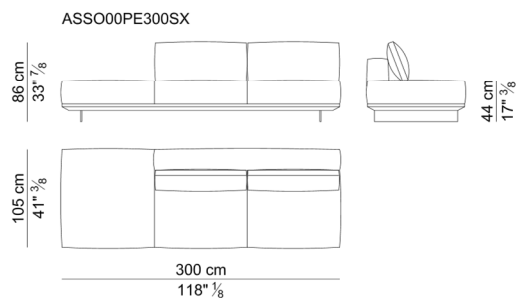
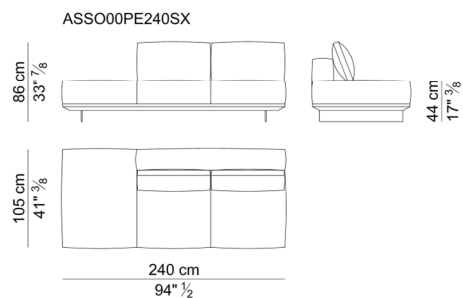
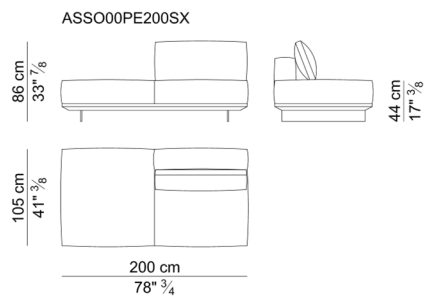
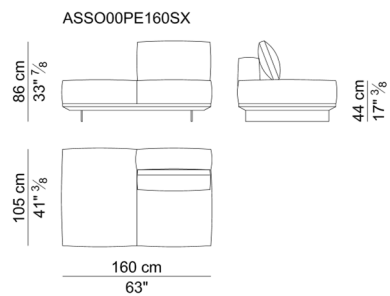

PENISOLE SINISTRE – LEFT LINEAR CHAISE LONGUES

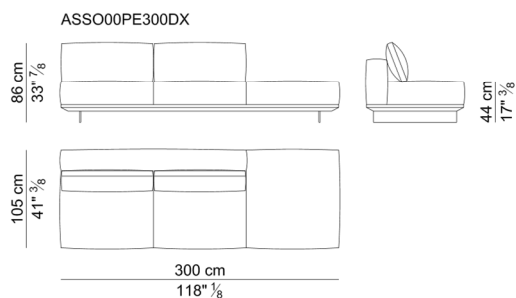
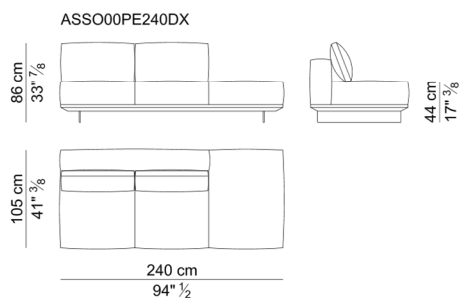
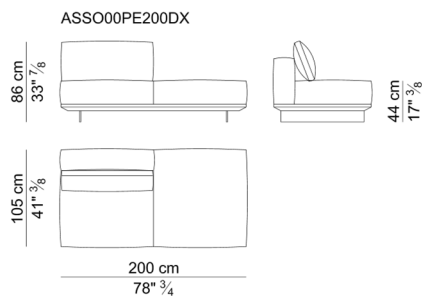
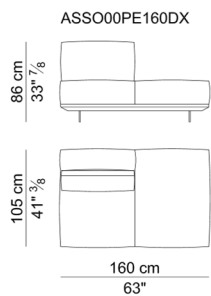

ELEMENTI CENTRALI – CENTRAL UNITS

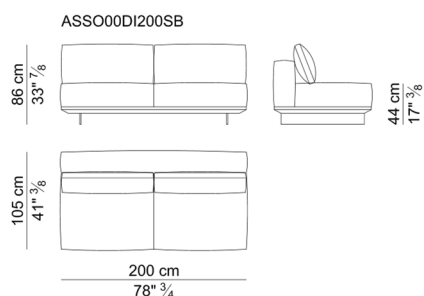
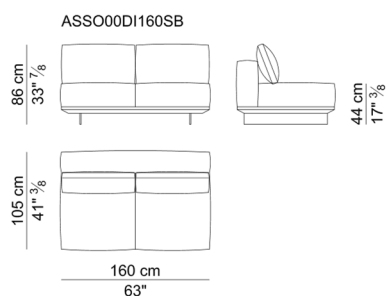

POUFF – OTTOMANS

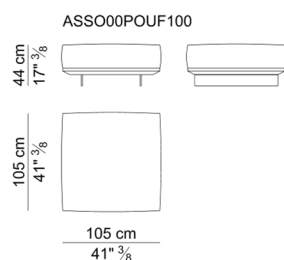

MODULI LIBRERIA E TAVOLINO – BOOKCASE AND LOW TABLE UNITS

