

DESIGN Luca Scacchetti – 2010



Scrivanie. I piani sono disponibili in tre finiture:

- realizzati con pannelli di nobilitato e rivestiti in cuoio o pelle;
- realizzati con pannelli di particelle di legno e impiallacciati;
- in cristallo extrachiaro con spessore 15 mm disponibile trasparente oppure verniciato in colore bianco, nero o RAL 1019.

Le gambe sono realizzate in pannello di nobilitato. Sono disponibili diverse versioni:

- con i bordi rivestiti in cuoio o pelle e parte centrale impiallacciata o in cristallo verniciato;
- completamente in cuoio o pelle;
- completamente impiallacciate.

Sulle gambe è fissato un elemento in acciaio cromato a forma di croce che serve da sostegno al piano al quale è fissato.

Cassettiera, allungo e mobili. Struttura realizzata sempre in pannello di nobilitato nero. Top e fianchi disponibili rivestiti completamente in cuoio o pelle, completamente impiallacciati oppure impiallacciati con bordi in cuoio o pelle. Frontali di ante e cassetti disponibili impiallacciati, rivestiti in cuoio o pelle oppure accoppiati a una lastra di vetro verniciato. Cassetti in multistrato laccati neri. Maniglie in alluminio lucido.

Cuoio e pelle. Le cuciture sono disponibili solamente nella versione in cuoio; nella versione in pelle non sono disponibili. In base alla categoria di cuoio scelta, la misura dei diversi "tagli" dello stesso può variare in maniera sensibile.

Essenze disponibili di serie: Eucalipto o Tipo Ebano. Altre finiture disponibili solo su richiesta.

Desks. The tops are available in three finishes:

- made with melamine coated panels and covered in saddle leather or soft leather;
- made with particleboard panels and veneered;
- in extra-clear glass with a thickness of 15 mm, available transparent or painted in white, black or RAL 1019.

The legs are made of melamine coated panel. Several versions are available:

- with edges covered in saddle leather or soft leather and central part veneered or with painted glass;
- completely in saddle leather or soft leather;
- completely veneered.

On the legs there is a cross-shaped chromed steel element that acts as a support for the top to which it is fixed.

Pedestal, return cabinet and cabinets. Frame always made in black melamine coated panel. Top and sides available completely covered in saddle leather or soft leather, completely veneered or veneered with saddle leather or soft leather edges. Fronts of doors and drawers available veneered, covered in saddle leather or soft leather or coupled with a painted glass plate. Drawers in black lacquered plywood. Polished aluminum handles.

Saddle leather and leather. The stitchings are available only in the saddle leather version; in the soft leather version they are not available. Depending on the category of saddle leather chosen, the size of its different "cuts" can vary significantly.

Standard wood veneers available: Eucalyptus wood or Ebony type wood. Other finishes available only on request.

PIANI SCRIVANIE – TOPS OF DESKS

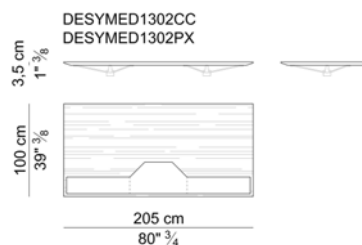
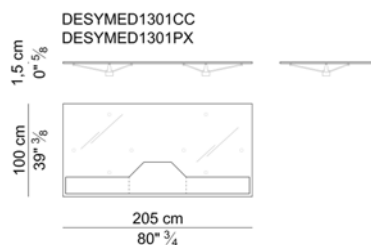
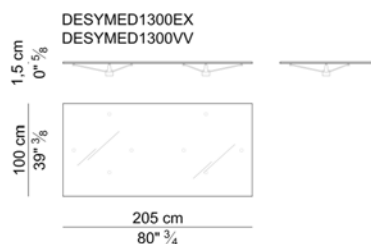
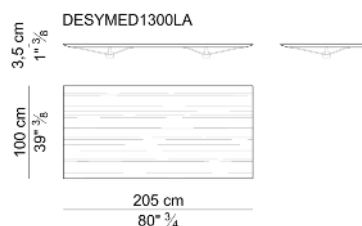
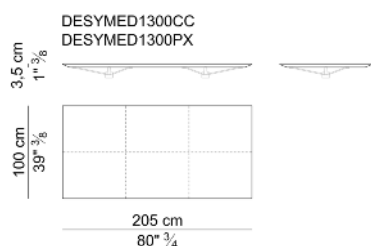

PIANI SCRIVANIE – TOPS OF DESKS

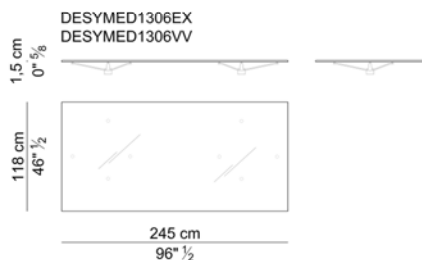
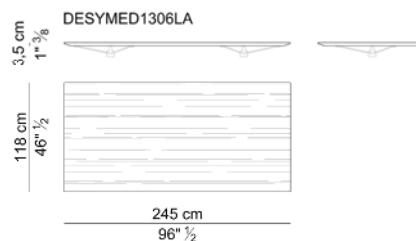
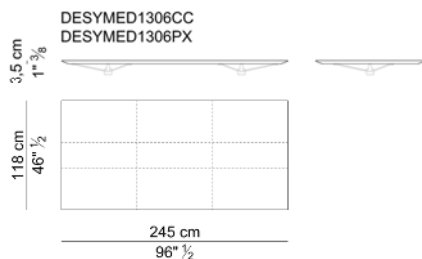
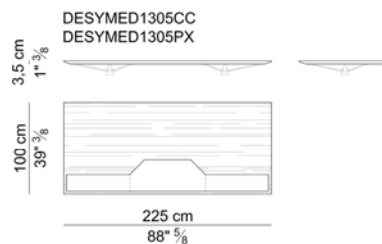
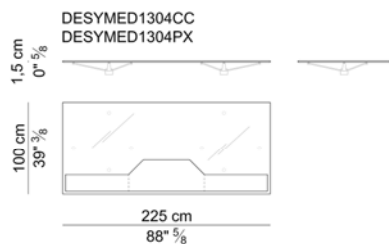
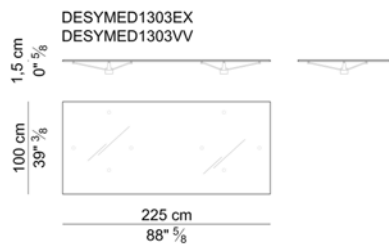
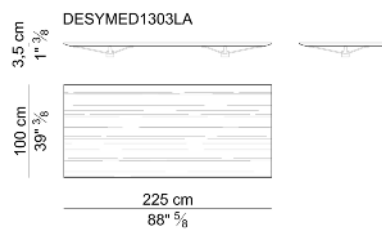
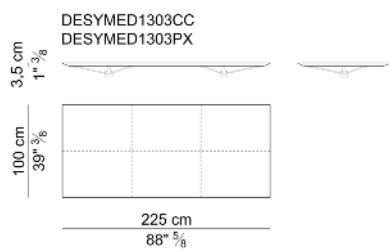

PIANI SCRIVANIE – TOPS OF DESKS

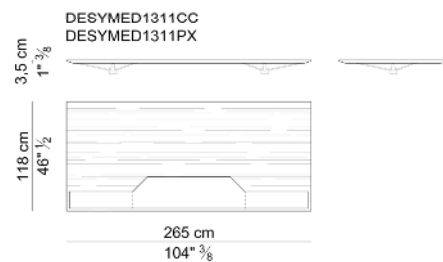
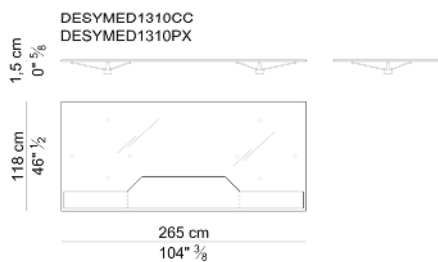
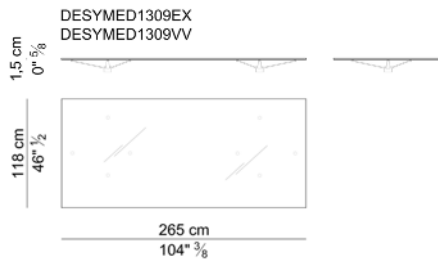
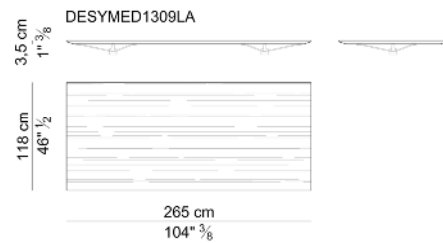
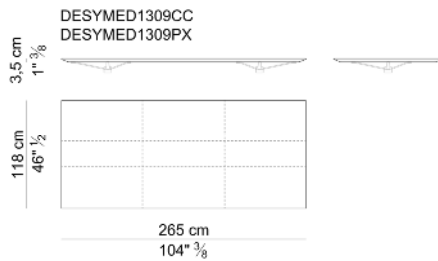
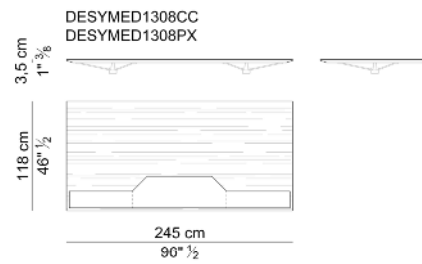
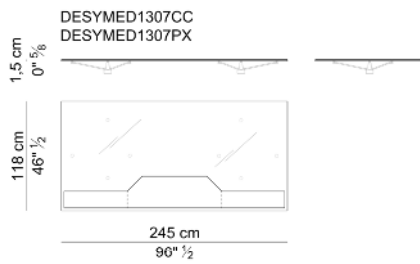

GAMBE PER PIANI SCRIVANIE – LEGS FOR TOP OF DESKS

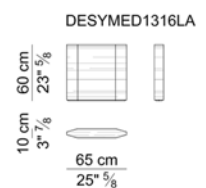
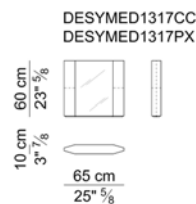
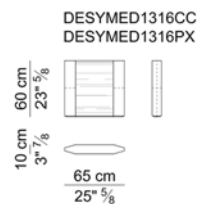

PANNELLI DI CORTESIA – MODESTY PANELS

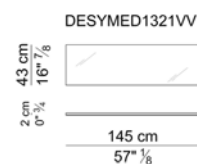
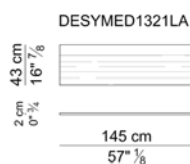
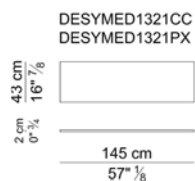
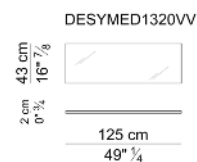
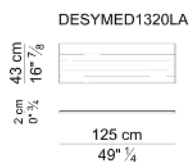
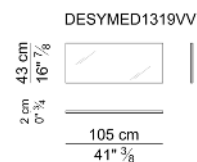
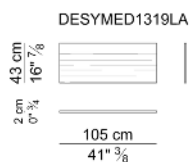
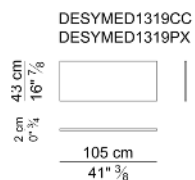
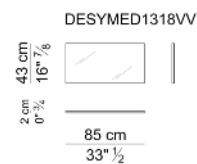
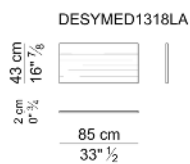
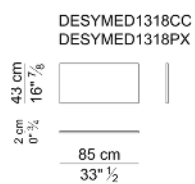

MOBILI ALLUNGO – SIDEBORD CABINETS

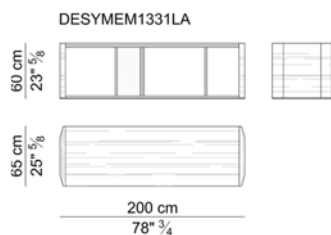
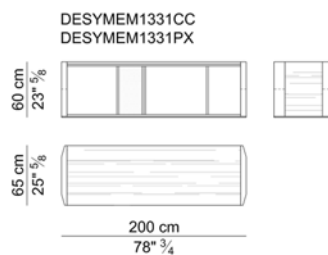
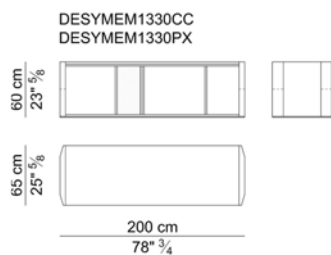

PANNELLI ANTE E CASSETTI PER MOBILI ALLUNGO – PANELS DOORS AND DRAWERS FOR SIDEBOARD CABINETS

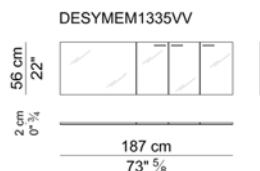
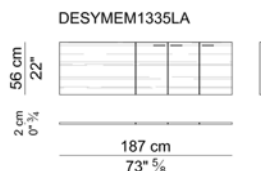
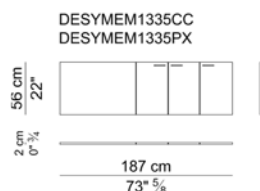
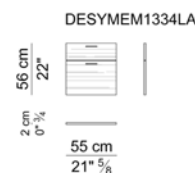
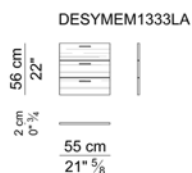
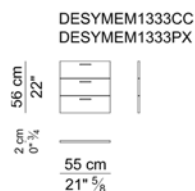
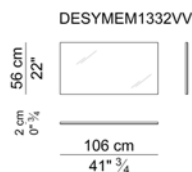
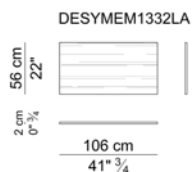
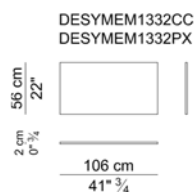

CASSETTIERE FISSE – FIXED PEDESTALS

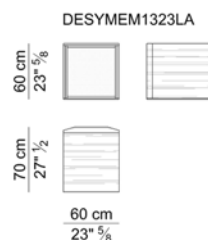
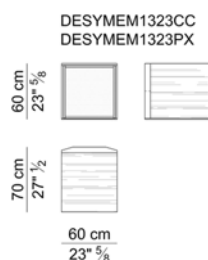
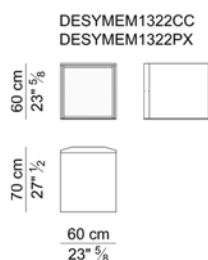

CASSETTI PER CASSETTIERE FISSE – DRAWERS FOR FIXED PEDESTALS

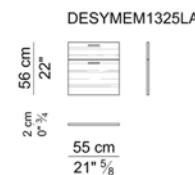
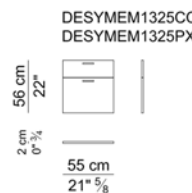
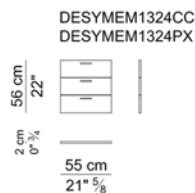

CASSETTIERE SU RUOTE – PEDESTALS ON CASTERS

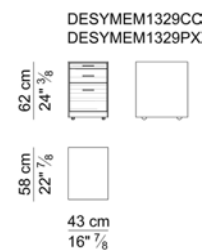
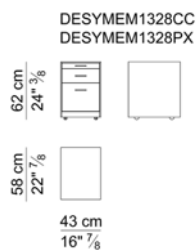
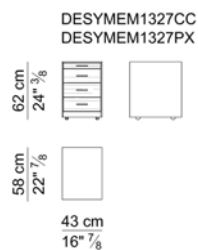
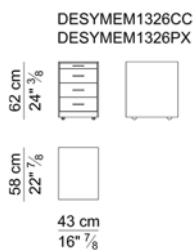

MOBILI BASSI – LOW CABINETS

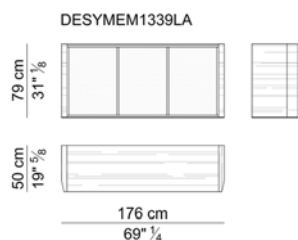
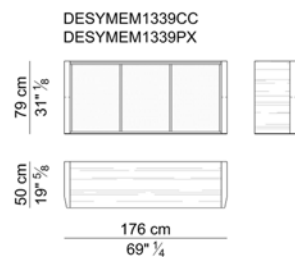
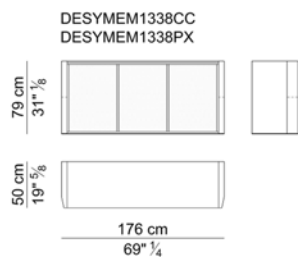
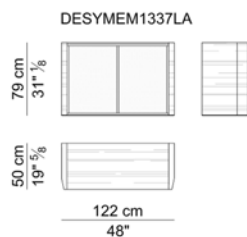
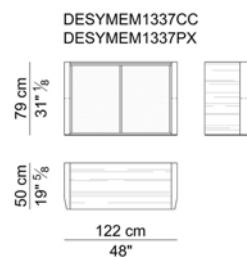
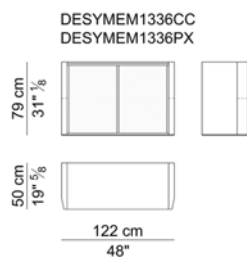

MOBILI BASSI- LOW CABINETS

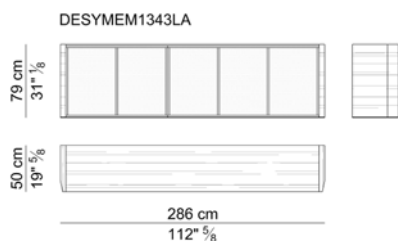
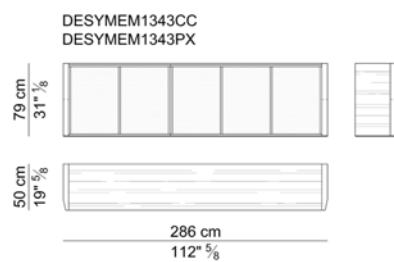
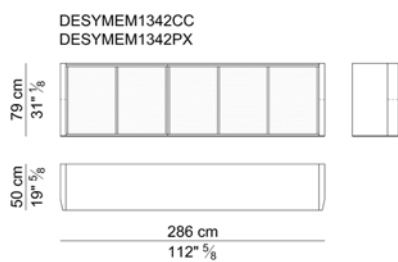
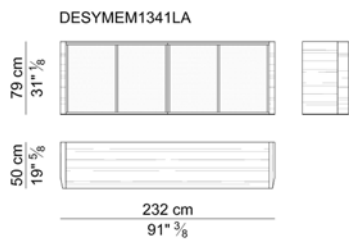
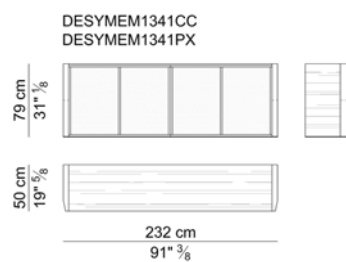
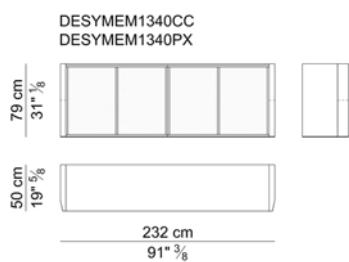

MOBILI ALTI – HIGH CABINETS

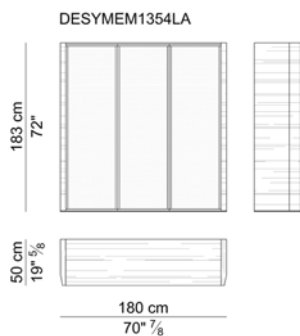
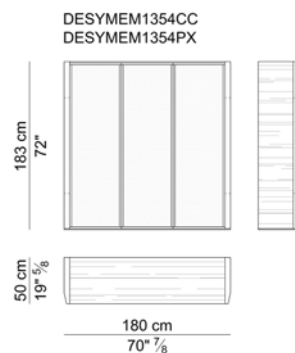
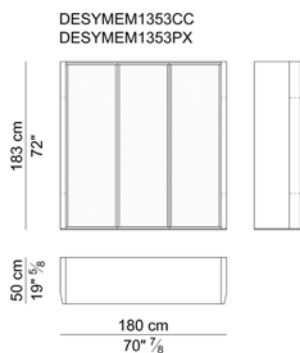
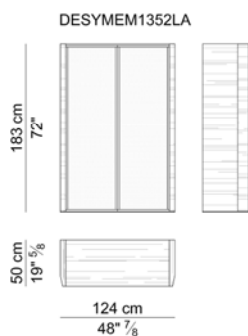
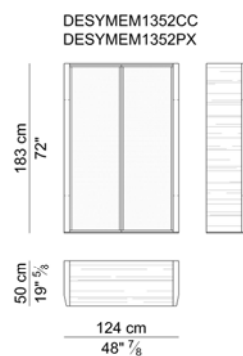
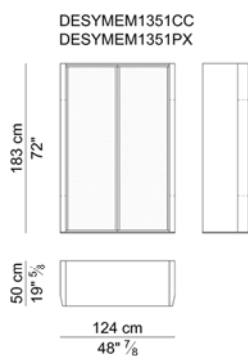

MOBILI ALTI – HIGH CABINETS

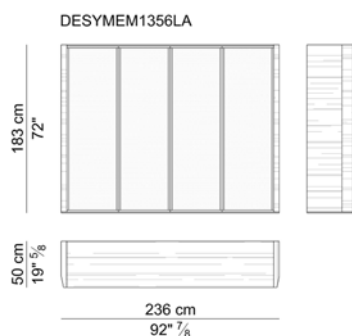
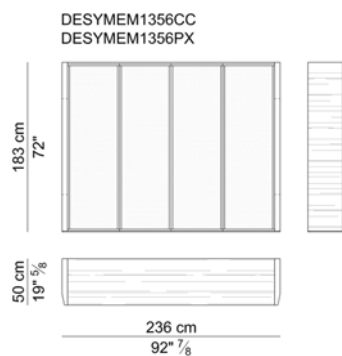
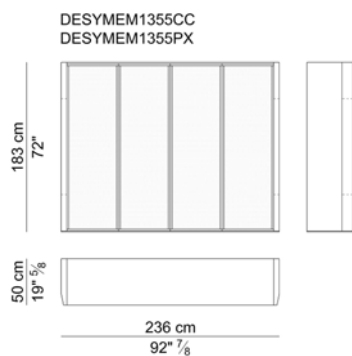

ANTE E CASSETTI PER MOBILI ALTI E BASSI – DOORS AND DRAWERS FOR HIGH AND LOW CABINETS

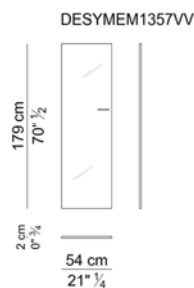
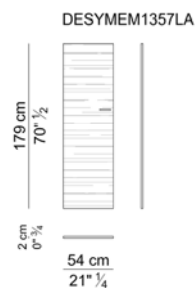
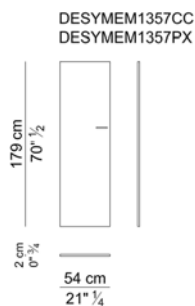
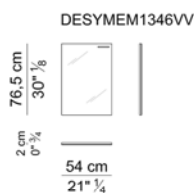
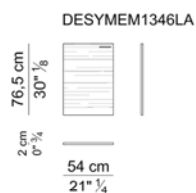

ANTE E CASSETTI PER MOBILI ALTI E BASSI – DOORS AND DRAWERS FOR HIGH AND LOW CABINETS

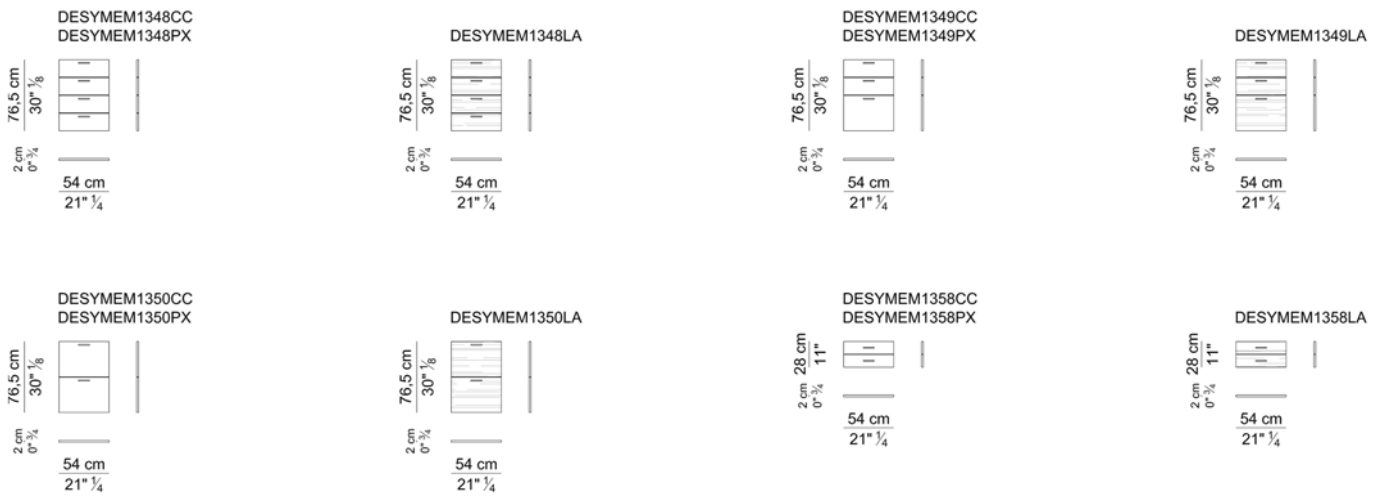

PIANI PER TAVOLINI – TOPS FOR LOW TABLES

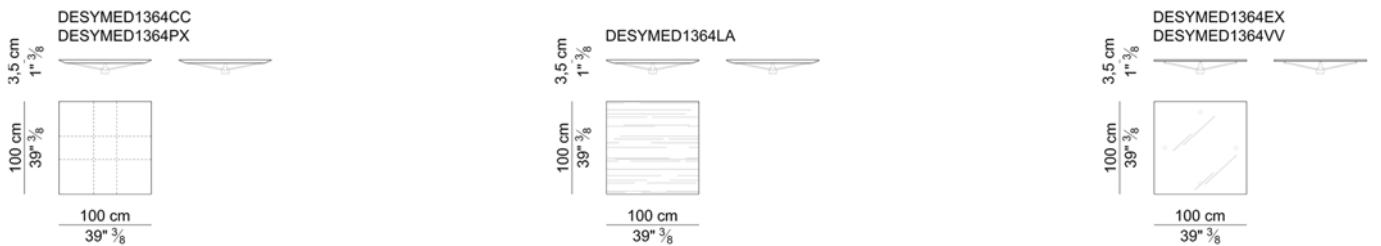

GAMBA PER TAVOLINI – LEG FOR LOW TABLES



MOBILI RECEPTION – RECEPTION COUNTERS

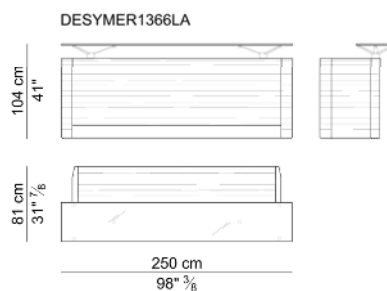
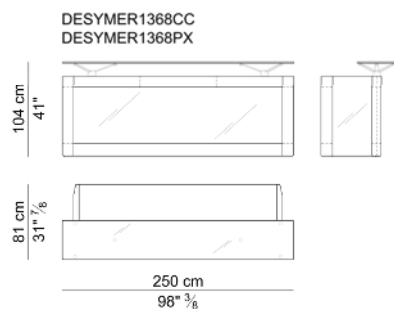
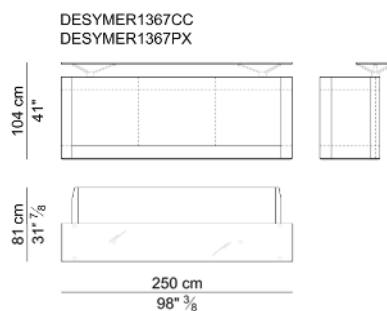
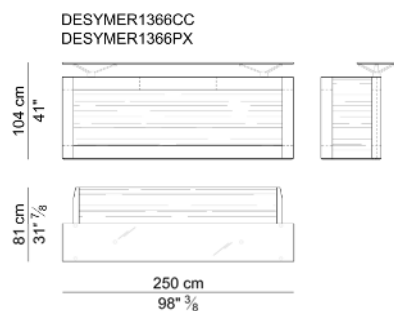

BOISERIES – WALL PANNELLING

